

IT/EN
2021/1

SAFETY
SHOES

innex
INNOVATIVE EXPERIENCE



“

Innex designs and manufactures the following PPE lines:

- + Ducati Workwear*
- + Innex High Risk and Workwear*
- + Customized workwear for company liveries*
- + The lightest safety shoes on the market*

The company Innex, acronym of Innovative Experience, was founded in 2015 as the result of a thirty-year experience in the field of production of PPE, with the purpose of renovating the market through innovative materials and new functional solutions.

Innex focus is on the values of the users: modern fitting, ergonomics, comfort and style distinguish all products in the Innex catalogue. It is well known in risky jobs, as well as in usual work activities, wearing comfortable clothing improves both safety and in productivity.

”

INNEX.

INNOVATIVE EXPERIENCE

“

Innex progetta e produce le seguenti linee di dispositivi di protezione individuale (DPI):

- + *l'abbigliamento da lavoro "Ducati Workwear"*
- + *abbigliamento "Innex" per rischi elevati multinorme e rischio generico*
- + *abbigliamento su commessa per "livree aziendali"*
- + *le calzature di sicurezza più leggere sul mercato*

L'azienda Innex, acronimo di Innovative Experience, è stata fondata nel 2015 a seguito di un'esperienza trentennale accumulata nel campo della produzione di DPI, con l'obiettivo di rinnovare il mercato attraverso l'uso di materiali innovativi e nuove soluzioni funzionali.

Conformità alle norme di sicurezza, ma anche ai valori essenziali per il lavoratore di vestibilità, ergonomia, comfort e stile: questa è la filosofia che ispira i prodotti Innex. Nelle situazioni di alto rischio, così come nelle normali attività lavorative, indossare abbigliamento confortevole si traduce in maggiore sicurezza e produttività.

”

BLOW.AIR
INSOCK

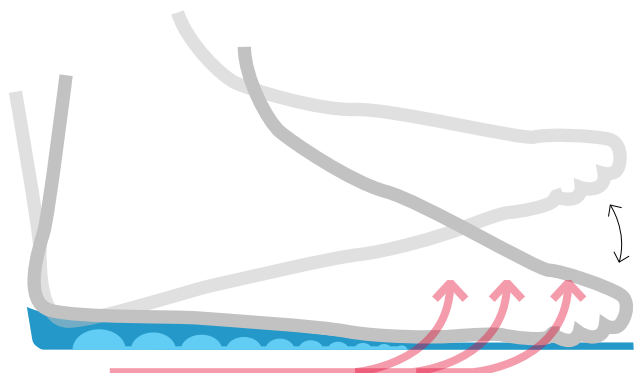

RIMUOVE
IL SUDORE

REMOVE
SWEAT

RIMUOVE
GLI ODORI

REMOVE
SMELLS

RIMUOVE
LA FATICA

REMOVE
FATIGUE

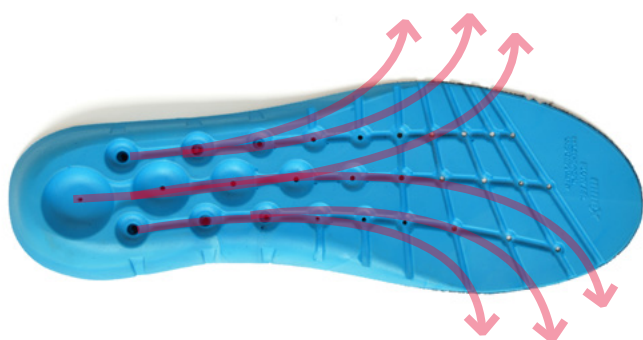

sistema attivo di
circolazione dell'aria
*active air circulation
system*

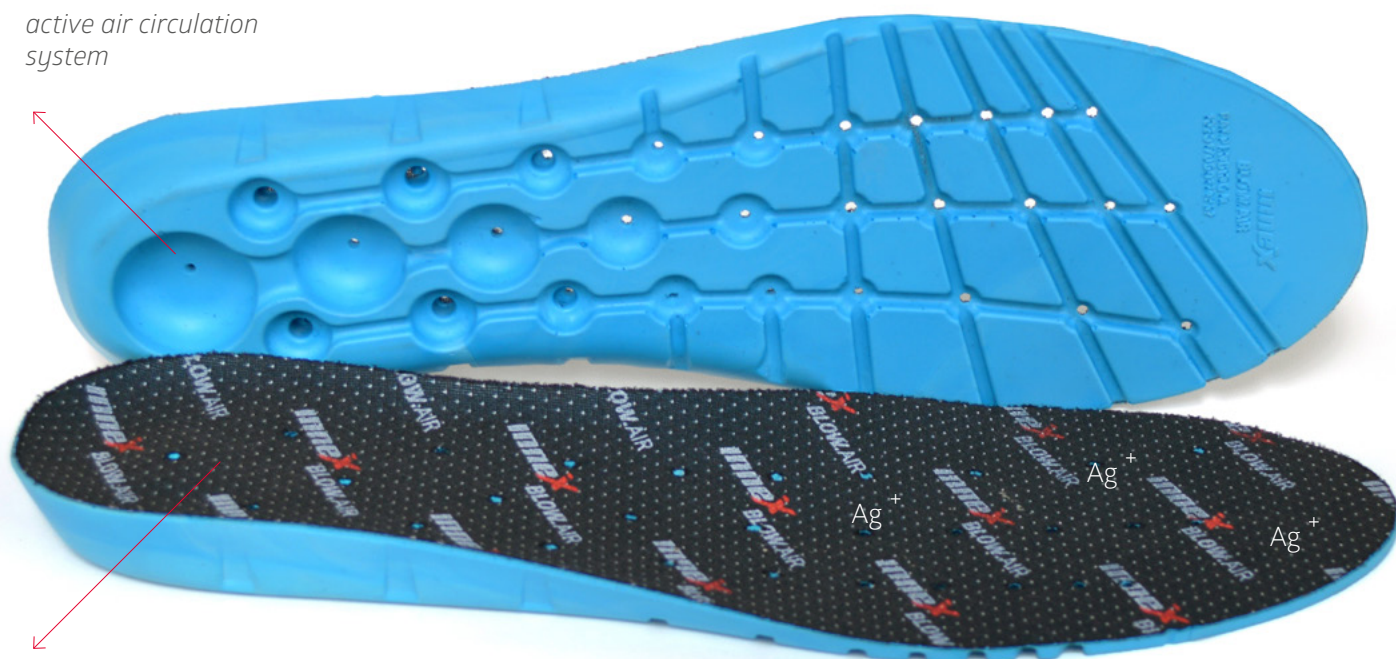

protegge dai batteri
grazie agli ioni d'argento
*protects from bacteria
with silver thread*



Blow.Air

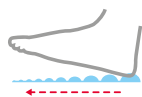

pompa l'aria
pumps the air

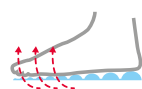

rinfresca il piede
refreshes the foot

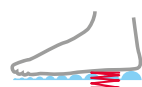

assorbe lo shock da impatto
absorbs impact shock



restituisce > 60% dell'energia generata dall'impatto
rebounds > 60 % of impact energy

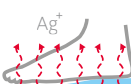

riduce il rischio di infezioni
reduces microbial risks



soletto ultra-flessibile
highly flexible insock

Il primo soletto con circolazione attiva dell'aria, che sfrutta il peso del corpo per produrre spostamento d'aria all'interno della scarpa e rinfrescare il piede.

The insock disegned with an active air circulation system. It uses body weight to move the air inside and refresh the shoe.

Blow.Air, con le sue **cupole elastiche**, sfrutta il peso del corpo per spostare aria nella calzatura, migliorando la termoregolazione con l'evacuazione di sudore.

Il materiale di cui è composto il soletto è uno speciale elastomero, Dyna.Flex, che **riduce lo shock** da impatto e **restituisce il 60%** dell'energia generata dall'impatto del tallone, sostenendo il peso del corpo: puoi camminare tutto il giorno e sentire caviglie, ginocchia e schiena sempre riposata.

La superficie esterna del soletto contiene **ioni d'argento** che riducono la carica batterica, conferendo proprietà antimicotiche, antiodore e antistatiche per tutta la durata del prodotto.

Blow.Air with its **elastic domes**, uses the body weight to move air into the shoe, improving the thermoregulation with the evacuation of sweat. The compound of the insock consists of a special elastomer, Dyna.Flex, able to **reduce impact shock** and to **return the 60%** of the energy generated by the impact of the heel, sustaining the body weight. While walking a lot, you'll feel rested at the end of the working day. The external surface of the insock contains **silver ions**, to reduce the bacterial load and provide an antifungal, anti-odor and antistatic activity throughout the life of the product.

Linee di flessione fisiologica

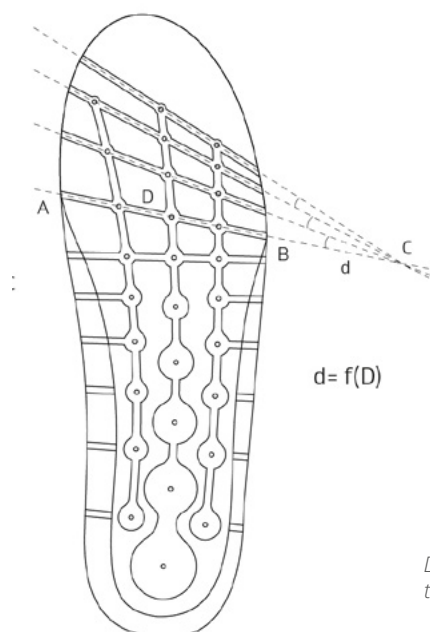

Drawing of the insock



INNEX. HELIUM



PLASTIC
TOECAP



TEXTILE
PENETRATION
RESISTANCE



ANTISTATIC
PROPERTIES



ENERGY
ABSORPTION
OF SEAT REGION



OIL
RESISTANCE



SLIP
RESISTANCE
SRC

JIMA

Art. 920INN1

S3 SRC

Categoria/Category

36-46

Taglie/Sizes

TOMAIA:

Pelle idrorepellente

UPPER:

Water-resistant leather

INSERTO RESISTENTE ALLA PERFORAZIONE:

In tessuto alta tenacità

MIDSOLE PENETRATION RESISTANT:

Textile high performance

PUNTALE:

Non metallico

TOECAP:

Non metallic

SUOLA:

PU leggero microcellulare

SOLE:

Microcells light PU

502 g

Peso/Weight *

ANTISTATIC PROPERTIES



ENERGY ABSORPTION OF SEAT REGION



OIL RESISTANCE



TEXTILE PENETRATION RESISTANCE



NON METALLIC TOECAP

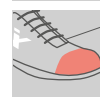

WATER PENETRATION AND ABSORPTION



* Peso di una sola calzatura, taglia 42.
Weight of one shoe, size 42.



TARAWA Art. 920INN10

S3 SRC Categoria/Category
36-46 Taglie/Sizes

TOMAIA:
 Pelle
 idrorepellente

UPPER:
 Water-resistant
 leather

**INSERTO RESISTENTE ALLA
 PERFORAZIONE:**
 In tessuto alta tenacità

**MIDSOLE PENETRATION
 RESISTANT:**
 Textile high performance

PUNTALE:
 Non metallico

TOECAP:
 Non metallic

SUOLA:
 PU leggero microcellulare

SOLE:
 Microcells light PU

545 g Peso/Weight *

ANTISTATIC
 PROPERTIES



ENERGY
 ABSORPTION
 OF SEAT REGION



OIL
 RESISTANCE



TEXTILE
 PENETRATION
 RESISTANCE



NON METALLIC
 TOECAP

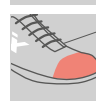

WATER
 PENETRATION
 AND ABSORPTION



* Peso di una sola
 calzatura, taglia 42.
 Weight of one shoe,
 size 42.



JUAN

Art. 920INN11

S3 SRC

Categoria/Category

36-46

Taglie/Sizes

TOMAIA:

Tessuto HT resistente all'abrasione idrorepellente

UPPER:

Water resistant HT textile wearing resistant

INSERTO RESISTENTE ALLA PERFORAZIONE:

In tessuto alta tenacità

MIDSOLE PENETRATION RESISTANT:

Textile high performance

PUNTALE:

Non metallico

TOECAP:

Non metallic

SUOLA:

PU leggero microcellulare

SOLE:

Microcells light PU

461 g

Peso/Weight *

ANTISTATIC PROPERTIES



ENERGY ABSORPTION OF SEAT REGION



OIL RESISTANCE



TEXTILE PENETRATION RESISTANCE



NON METALLIC TOECAP

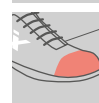

WATER PENETRATION AND ABSORPTION



* Peso di una sola calzatura, taglia 42.
Weight of one shoe, size 42.



JORGE

Art. 920INN20

S3 SRC

Categoria/Category

36-46

Taglie/Sizes

TOMAIA:

Tessuto HT resistente all'abrasione idrorepellente

UPPER:

Water resistant HT textile wearing resistant

INSERTO RESISTENTE ALLA PERFORAZIONE:

In tessuto alta tenacità

MIDSOLE PENETRATION RESISTANT:

Textile high performance

PUNTALE:

Non metallico

TOECAP:

Non metallic

SUOLA:

PU leggero microcellulare

SOLE:

Microcells light PU

498 g

Peso/Weight *



* Peso di una sola calzatura, taglia 42.
Weight of one shoe, size 42.



MOLOKAI

Art. 920INN2

S1P SRC

Categoria/Category

36-46

Taglie/Sizes

TOMAIA:

Tessuto HT microforato

UPPER:

Micro-perforated HT fabric

**INSERTO RESISTENTE ALLA
PERFORAZIONE:**

In tessuto alta tenacità

**MIDSOLE PENETRATION
RESISTANT:**

Textile high performance

PUNTALE:

Non metallico

TOECAP:

Non metallic

SUOLA:

PU leggero microcellulare

SOLE:

Microcells light PU

472 g

Peso/Weight*

ANTISTATIC
PROPERTIES



ENERGY
ABSORPTION
OF SEAT REGION



OIL
RESISTANCE



TEXTILE
PENETRATION
RESISTANCE



NON METALLIC
TOECAP

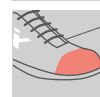

* Peso di una sola calzatura, taglia 42.
Weight of one shoe, size 42.



MINAMI Art. 920INN6

S1P SRC Categoria/Category

36-46 Taglie/Sizes

TOMAIA:
Pelle scamosciata

UPPER:
Suede leather

**INSERTO RESISTENTE ALLA
PERFORAZIONE:**
In tessuto alta tenacità

**MIDSOLE PENETRATION
RESISTANT:**
Textile high performance

PUNTALE:
Non metallico

TOECAP:
Non metallic

SUOLA:
PU leggero microcellulare

SOLE:
Microcells light PU

482 g Peso/Weight *

ANTISTATIC
PROPERTIES



ENERGY
ABSORPTION
OF SEAT REGION



OIL
RESISTANCE



TEXTILE
PENETRATION
RESISTANCE



NON METALLIC
TOECAP

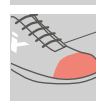

* Peso di una sola calzatura, taglia 42.
Weight of one shoe, size 42.



TENERIFE

Art. 920INN22

S1P SRC

Categoria/Category

36-46

Taglie/Sizes

TOMAIA:

Pelle scamosciata con collarino in tessuto stretch

UPPER:

Suede leather with stretch textile collar

INSERTO RESISTENTE ALLA PERFORAZIONE:

In tessuto alta tenacità

MIDSOLE PENETRATION RESISTANT:

Textile high performance

PUNTALE:

Non metallico

TOECAP:

Non metallic

SUOLA:

PU leggero microcellulare

SOLE:

Microcells light PU

467 g

Peso/Weight *

ANTISTATIC PROPERTIES



ENERGY ABSORPTION OF SEAT REGION



OIL RESISTANCE



TEXTILE PENETRATION RESISTANCE



NON METALLIC TOECAP

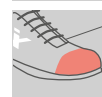

* Peso di una sola calzatura, taglia 42.
Weight of one shoe, size 42.



LINGUETTA TRAFORATA STRETCH
STRETCH PERFORATED TONGUE



INNEX.

KRYPTON



STEEL
TOECAP



TEXTILE
PENETRATION
RESISTANCE



ANTISTATIC
PROPERTIES



ENERGY
ABSORPTION
OF SEAT REGION



OIL
RESISTANCE



SLIP
RESISTANCE
SRC



SALDATURA, SIDERURGIA? PIÙ COMFORT CON **KRYPTON**

Collare a **sfilamento rapido** senza lacci
Quick release collar without laces

Morbida pelle fiore
Soft full-grain leather collar

Tomaio con **minimo uso di cuciture**: maggior comfort e idrorepellenza

Upper with minimum use of seams: greater comfort and water repellency

Interamente cucita con **filato ignifugo**

Entirely sewn with fireproof yarn

FOGO
S3 SRC
910INN10



Ramponi alti smussati e distanziati per **autopulizia**

High and rounded sole cleats to be self-cleaning

Resistenza allo scivolamento
SRC EN 20345 > 60%

Slip resistance SRC EN 20345 > 60%

PICO Art. 910INN8

S3 SRC Categoria/Category
36-48 Taglie/Sizes

TOMAIA:
 Nubuck ingrassato
 idrorepellente

UPPER:
 Water-resistant
 waxy nubuck

**INSERTO RESISTENTE ALLA
 PERFORAZIONE:**
 In tessuto alta tenacità

**MIDSOLE PENETRATION
 RESISTANT:**
 Textile high performance

PUNTALE:
 Acciaio

TOECAP:
 Steel

SUOLA:
 PU/PU microcellulare

SOLE:
 Microcells PU/PU

590 g Peso/Weight *

ANTISTATIC
 PROPERTIES



ENERGY
 ABSORPTION
 OF SEAT REGION



OIL
 RESISTANCE



TEXTILE
 PENETRATION
 RESISTANCE



STEEL
 TOECAP

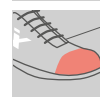

WATER
 PENETRATION
 AND ABSORPTION



* Peso di una sola
 calzatura, taglia 42.
 Weight of one shoe,
 size 42.

NEW



LINGUA IN MORBIDA
 PELLE FIORE
 SOFT FULL-GRAIN
 LEATHER TONGUE

ROCKALL Art. 910INN9

S3 SRC Categoria/Category
36-48 Taglie/Sizes

TOMAIA:
 Nubuck ingrassato
 idrorepellente

UPPER:
 Water-resistant
 waxy nubuck

**INSERTO RESISTENTE ALLA
 PERFORAZIONE:**
 In tessuto alta tenacità

**MIDSOLE PENETRATION
 RESISTANT:**
 Textile high performance

PUNTALE:
 Acciaio

TOECAP:
 Steel

SUOLA:
 PU/PU microcellulare

SOLE:
 Microcells PU/PU

618 g Peso/Weight*



* Peso di una sola calzatura, taglia 42.
 Weight of one shoe, size 42.

NEW



COLLARE E LINGUA IN
 MORBIDA PELLE FIORE
 SOFT FULL-GRAIN LEATHER
 COLLAR AND TONGUE

PRASLIN Art. 910INN1

S3 SRC Categoria/Category
36-48 Taglie/Sizes

TOMAIA:
 Nubuck ingrassato
 idrorepellente

UPPER:
 Water-resistant
 waxy nubuck

**INSERTO RESISTENTE ALLA
 PERFORAZIONE:**
 In tessuto alta tenacità

**MIDSOLE PENETRATION
 RESISTANT:**
 Textile high performance

PUNTALE:
 Acciaio

TOECAP:
 Steel

SUOLA:
 PU/PU microcellulare

SOLE:
 Microcells PU/PU

566 g Peso/Weight *

ANTISTATIC
 PROPERTIES



ENERGY
 ABSORPTION
 OF SEAT REGION



OIL
 RESISTANCE



TEXTILE
 PENETRATION
 RESISTANCE



STEEL
 TOECAP

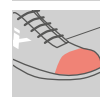

WATER
 PENETRATION
 AND ABSORPTION



* Peso di una sola
 calzatura, taglia 42.
 Weight of one shoe,
 size 42.

NEW

COLLARE E LINGUA IN
 MORBIDA PELLE FIORE
 SOFT FULL-GRAIN LEATHER
 COLLAR AND TONGUE



PEMBA Art. 910INN2

S3 SRC Categoria/Category

36-48 Taglie/Sizes

TOMAIA:
Nubuck ingrassato
idrorepellente

UPPER:
Water-resistant
waxy nubuck

**INSERTO RESISTENTE ALLA
PERFORAZIONE:**
In tessuto alta tenacità

**MIDSOLE PENETRATION
RESISTANT:**
Textile high performance

PUNTALE:
Acciaio

TOECAP:
Steel

SUOLA:
PU/PU microcellulare

SOLE:
Microcells PU/PU

605 g Peso/Weight*

ANTISTATIC
PROPERTIES



ENERGY
ABSORPTION
OF SEAT REGION



OIL
RESISTANCE



TEXTILE
PENETRATION
RESISTANCE



STEEL
TOECAP

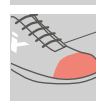

WATER
PENETRATION
AND ABSORPTION



* Peso di una sola calzatura, taglia 42.
Weight of one shoe,
size 42.

NEW



COLLARE E LINGUA IN
MORBIDA PELLE FIORE
SOFT FULL-GRAIN LEATHER
COLLAR AND TONGUE

PIERRE Art. 910INN12

S3 SRC Categoria/Category
36-48 Taglie/Sizes

TOMAIA:
 Pelle
 idrorepellente

UPPER:
 Water-resistant
 leather

**INSERTO RESISTENTE ALLA
 PERFORAZIONE:**
 In tessuto alta tenacità

**MIDSOLE PENETRATION
 RESISTANT:**
 Textile high performance

PUNTALE:
 Acciaio

TOECAP:
 Steel

SUOLA:
 PU/PU microcellulare

SOLE:
 Microcells PU/PU

585 g Peso/Weight*

ANTISTATIC
 PROPERTIES



ENERGY
 ABSORPTION
 OF SEAT REGION



OIL
 RESISTANCE



TEXTILE
 PENETRATION
 RESISTANCE



STEEL
 TOECAP

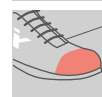

WATER
 PENETRATION
 AND ABSORPTION



* Peso di una sola calzatura, taglia 42.
 Weight of one shoe,
 size 42.

NEW



PONZA Art. 910INN13

S3 SRC Categoria/Category
36-48 Taglie/Sizes

TOMAIA:
 Pelle
 idrorepellente

UPPER:
 Water-resistant
 leather

**INSERTO RESISTENTE ALLA
 PERFORAZIONE:**
 In tessuto alta tenacità

**MIDSOLE PENETRATION
 RESISTANT:**
 Textile high performance

PUNTALE:
 Acciaio

TOECAP:
 Steel

SUOLA:
 PU/PU microcellulare

SOLE:
 Microcells PU/PU

607 g Peso/Weight*

ANTISTATIC
 PROPERTIES



ENERGY
 ABSORPTION
 OF SEAT REGION



OIL
 RESISTANCE



TEXTILE
 PENETRATION
 RESISTANCE



STEEL
 TOECAP

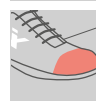

WATER
 PENETRATION
 AND ABSORPTION



* Peso di una sola calzatura, taglia 42.
 Weight of one shoe,
 size 42.

NEW



MARRAN Art. 910INN5

S3 SRC Categoria/Category
36-48 Taglie/Sizes

TOMAIA:
 Nubuck ingrassato
 idrorepellente

UPPER:
 Water-resistant
 waxy nubuck

**INSERTO RESISTENTE ALLA
 PERFORAZIONE:**
 In tessuto alta tenacità

**MIDSOLE PENETRATION
 RESISTANT:**
 Textile high performance

PUNTALE:
 Acciaio

TOECAP:
 Steel

SUOLA:
 PU/PU microcellulare

SOLE:
 Microcells PU/PU

574 g Peso/Weight *



* Peso di una sola calzatura, taglia 42.
 Weight of one shoe, size 42.



Tomaia senza allacciatura con
 minimo uso di cuciture
*Uppers without lacing with
 minimum use of seams*

NEW



COLLARE ELASTICIZZATO
 STRETCH COLLAR

PARTE FRONTALE CON UNA SOLA
 CUCITURA INCROCIATA
 FOREPART WITH ONE CROSS
 STITCHING



FOGO

Art. 910INN10

S3 SRC

Categoria/Category

36-48

Taglie/Sizes

TOMAIA:

Nubuck ingrassato idrorepellente e collare in pelle fiore

UPPER:

Water-resistant waxy nubuck and full-grain leather collar

INSERTO RESISTENTE ALLA PERFORAZIONE:

In tessuto alta tenacità

MIDSOLE PENETRATION RESISTANT:

Textile high performance

PUNTALE:

Acciaio

TOECAP:

Steel

SUOLA:

PU/PU microcellulare

SOLE:

Microcells PU/PU



592 g

Peso/Weight *

* Peso di una sola calzatura, taglia 42.
Weight of one shoe, size 42.



NEW

Tomaia senza allacciatura con minimo uso di cuciture
Uppers without lacing with minimum use of seams

COLLARE IN MORBIDA PELLE FIORE
SOFT FULL-GRAIN LEATHER COLLAR

CUCITO INTERAMENTE CON FILATO IGNIFUGO ARAMIDICO
ENTIRELY SEWED WITH ARAMID FR THREAD

PARTE FRONTALE CON UNA SOLA CUCITURA INCROCIATA
FOREPART WITH ONE CROSS STITCHING



FUERTE

Art. 910INN3

S1P SRC

Categoria/Category

36-48

Taglie/Sizes

TOMAIA:

Pelle scamosciata

UPPER:

Suede leather

**INSERTO RESISTENTE ALLA
PERFORAZIONE:**

In tessuto alta tenacità

**MIDSOLE PENETRATION
RESISTANT:**

Textile high performance

PUNTALE:

Acciaio

TOECAP:

Steel

SUOLA:

PU/PU microcellulare

SOLE:

Microcells PU/PU

552 g

Peso/Weight*

ANTISTATIC
PROPERTIES



ENERGY
ABSORPTION
OF SEAT REGION



OIL
RESISTANCE



TEXTILE
PENETRATION
RESISTANCE



STEEL
TOECAP

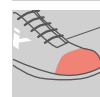

* Peso di una sola
calzatura, taglia 42.
Weight of one shoe,
size 42.

NEW



KOOLAN Art. 910INN4

S1P SRC Categoria/Category

36-48 Taglie/Sizes

TOMAIA: Pelle scamosciata **UPPER:** Suedeleather

INSERTO RESISTENTE ALLA PERFORAZIONE: In tessuto alta tenacità **MIDSOLE PENETRATION RESISTANT:** Textile high performance

PUNTALE: Acciaio **TOECAP:** Steel

SUOLA: PU/PU microcellulare **SOLE:** Microcells PU/PU

563 g Peso/Weight *

ANTISTATIC PROPERTIES



ENERGY ABSORPTION OF SEAT REGION



OIL RESISTANCE



TEXTILE PENETRATION RESISTANCE



STEEL TOECAP

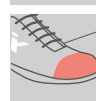

* Peso di una sola calzatura, taglia 42.
Weight of one shoe, size 42.



NEW

Tomaia senza allacciatura con minimo uso di cuciture
Uppers without lacing with minimum use of seams



COLLARE ELASTICIZZATO
STRETCH COLLAR

PARTE FRONTALE CON UNA SOLA CUCITURA INCROCIATA
FOREPART WITH ONE CROSS STITCHING

BALI Art. 910INN6

S2 SRC Categoria/Category
36-48 Taglie/Sizes

TOMAIA:
 Microfibra
 idrorepellente

UPPER:
 Water-resistant
 microfibre

**INSERTO RESISTENTE ALLA
 PERFORAZIONE:**
 In tessuto alta tenacità

**MIDSOLE PENETRATION
 RESISTANT:**
 Textile high performance

PUNTALE:
 Acciaio

TOECAP:
 Steel

SUOLA:
 PU/PU microcellulare

SOLE:
 Microcells light PU/PU

429 g Peso/Weight *



* Peso di una sola calzatura, taglia 42.
 Weight of one shoe, size 42.



Tomaia senza allacciatura con minimo uso di cuciture
Uppers without lacing with minimum use of seams

NEW



COLLARE ELASTICIZZATO
 STRETCH COLLAR

PARTE FRONTALE CON UNA SOLA
 CUCITURA INCROCIATA
 FOREPART WITH ONE CROSS
 STITCHING



CORVO Art. 910INN7

S2 SRC Categoria/Category

36-48 Taglie/Sizes

TOMAIA:
Microfibra
idrorepellente

UPPER:
Water-resistant
microfibre

**INSERTO RESISTENTE ALLA
PERFORAZIONE:**
In tessuto alta tenacità

**MIDSOLE PENETRATION
RESISTANT:**
Textile high performance

PUNTALE:
Acciaio

TOECAP:
Steel

SUOLA:
PU/PU microcellulare

SOLE:
Microcells light PU/PU

429 g Peso/Weight *

ANTISTATIC
PROPERTIES



ENERGY
ABSORPTION
OF SEAT REGION



OIL
RESISTANCE



STEEL
TOECAP



WATER
PENETRATION
AND ABSORPTION



* Peso di una sola calzatura, taglia 42.
Weight of one shoe, size 42.



NEW

































Tomaia senza allacciatura con
minimo uso di cuciture
*Uppers without lacing with
minimum use of seams*



COLLARE ELASTICIZZATO
STRETCH COLLAR

PARTE FRONTALE CON UNA SOLA
CUCITURA INCROCIATA
FOREPART WITH ONE CROSS
STITCHING

Helium

ART.	PHOTO	ANTISTATIC PROPERTIES	ENERGY ABSORPTION OF SEAT REGION	OIL RESISTANCE	TEXTILE PENETRATION RESISTANCE	TOECAP	WATER PENETRATION AND ABSORPTION	PAG.
JIMA 920INN1						PLASTIC 		8
TARAWA 920INN10						PLASTIC 		9
JUAN 920INN11						PLASTIC 		10
JORGE 920INN20						PLASTIC 		11
MOLOKAI 920INN2						PLASTIC 		12
MINAMI 920INN6						PLASTIC 		13
TENERIFE 920INN22						PLASTIC 		14



Krypton





















































































ART.	PHOTO	ANTISTATIC PROPERTIES	ENERGY ABSORPTION OF SEAT REGION	OIL RESISTANCE	TEXTILE PENETRATION RESISTANCE	TOECAP	WATER PENETRATION AND ABSORPTION	PAG.
PICO 910INN8						STEEL 		18
ROCKALL 910INN9						STEEL 		19
PRASLIN 910INN1						STEEL 		20
PEMBA 910INN2						STEEL 		21
PIERRE 910INN12						STEEL 		22
PONZA 910INN13						STEEL 		23
MARRAN 910INN5						STEEL 		24
FOGO 910INN10						STEEL 		25
FUERTE 910INN3						STEEL 		26
KOOLAN 910INN4						STEEL 		27
BALI 910INN6						STEEL 		28
CORVO 910INN7						STEEL 		29

TABELLA TAGLIE

SIZE CHART

TAGLIE EUROPEE <i>EU SIZES</i>	TAGLIE UK <i>UK SIZES</i>
35	3
36	4
37	4.5
38	5
39	6
40	6.5
41	7
42	8
43	9
44	10
45	11
46	11.5
47	12
48	13
49	13.5

Dotted lines for writing notes.



Prodotto e distribuito da /
Produced and distributed by

INNEX S.r.l.
Via dell'Unione Europea, 6
76121 Barletta (BT) IT

t +39 0883 1984911
f +39 0883 1984920
e info@innex.it
w www.innex.it